

# TOSHIBA

## PROGRAMMABLE CONTROLLER PROSEC T1/T1S

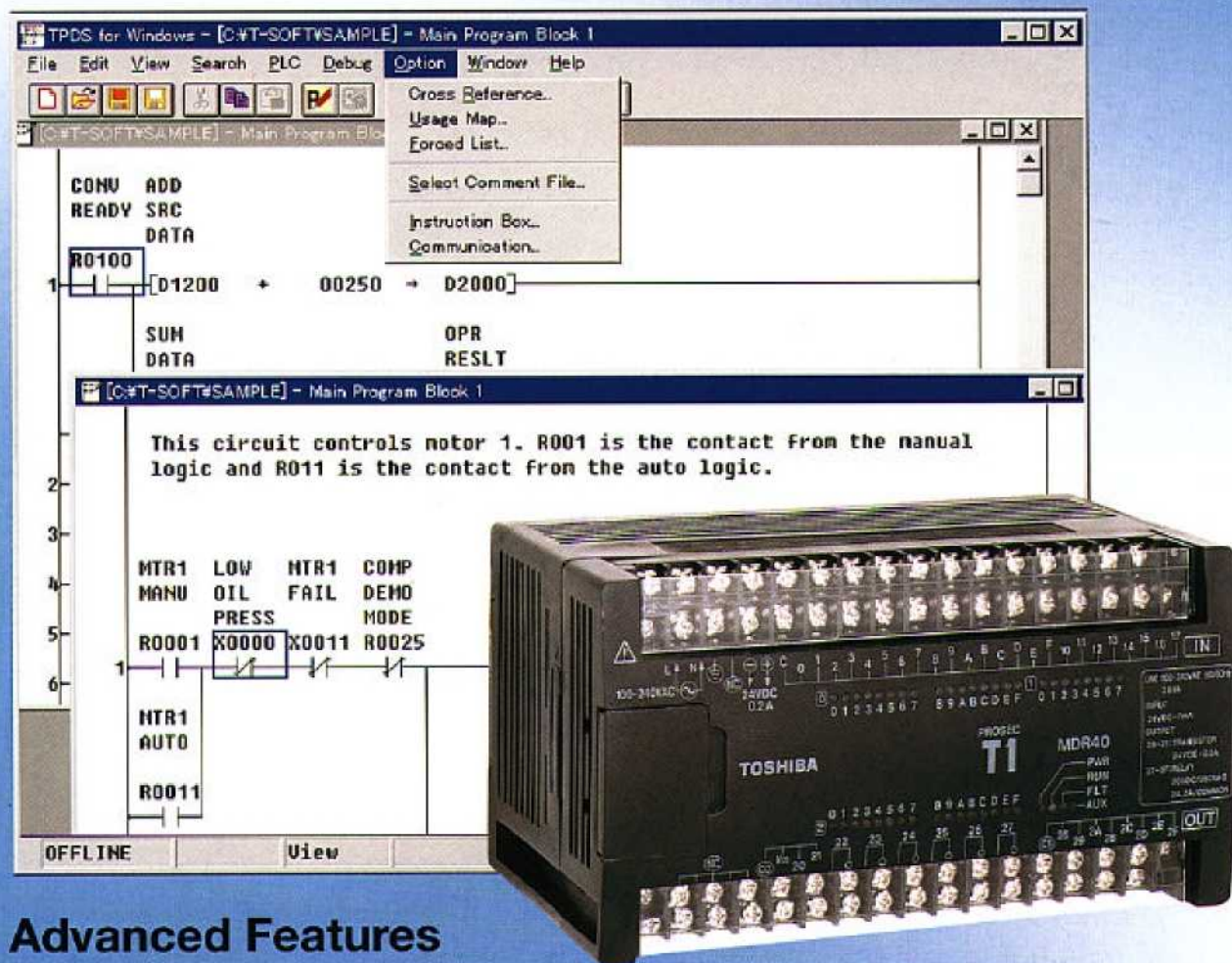

### Advanced Features

- High-Speed Processing
- High Performance Software
- Unique I/O Option Cards
- Built-in Computer Interface and Active Serial Port
- ASCII Message Storage in Register & Program Memory
- MS Windows Programming Software

# PROSEC T1 Series Micro Programmable Controllers

T1s are the micro programmable controllers in Toshiba's popular T-Series family. They are full-fledged members of the T-Series family and all programs written for a T1 will run on other T-Series controllers. The T1s are palm-sized controllers with CPU, I/O and power supply all in one small block. The T1's small size make it ideal for a variety of applications including:

- Packaging Machinery
- Punch Press Control
- Material Handling
- Washing & Drying Control
- Pneumatic Control
- Conveyer Control
- Compliance Monitoring
- Many Others

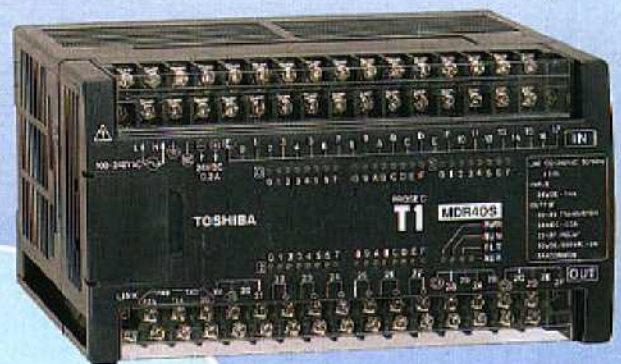
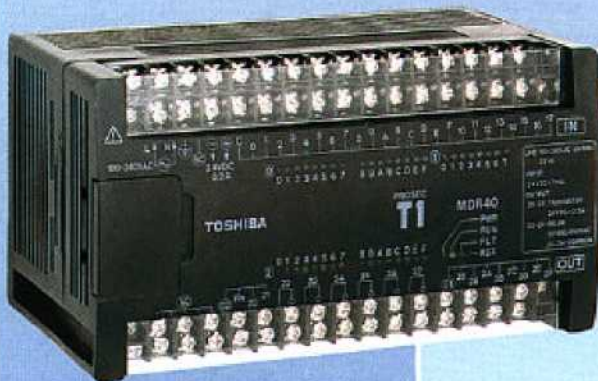

# Flexible I/O

The T1 Series consist of four models, T1-16, T1-28, T1-40 and T1-40S. All four are block style controllers allowing for I/O to be economically matched to specific requirements.

The T1-16 and T1-28 are fixed I/O non-expandable controllers. The T1-40 and T1-40S I/O, however, can be expanded. The I/O can be expandable three ways:

## Option Cards

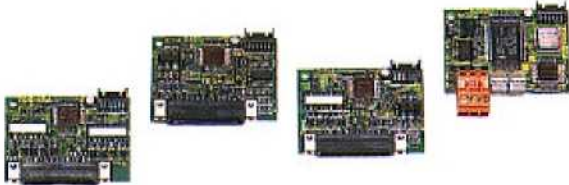

Toshiba used its advanced surface mount technology to develop an extremely compact I/O option card. The I/O option cards are approximately 1/2 the size of a credit card. The T1-40/T1-40S can hold two I/O option cards inserted in the end of the controller. The following option cards are currently available.

- 16 points DC input
- 16 points DC output
- 8 DC in/8 DC out combo
- 1 channel Analog output
- 1 channel Analog output
- Field network TOSLINE-F10 remote

## Expansion Rack

The T1-40/T1-40S can be connected to a two/four slot expansion rack allowing it to utilize most T2 Series I/O modules.

The following I/O modules are available for T1-40/T1-40S.

- 16 points DC input
- 32 points DC input
- 64 points DC input
- 16 points AC input
- 8 points relay output
- 4 channels analog input
- 1 channel pulse input
- Communication interface
- 16 points DC output
- 32 points DC output
- 64 points DC output
- 12 points AC output
- 12 points relay output
- 2 channels analog output
- 1 axis position control



## Expansion Unit

A block type expansion unit is also available.

Each expansion unit has 32 I/O points (16 inputs and 16 outputs). The T1-40/T1-40S can be connected to either one expansion rack or one expansion unit.



# T1 Series Line-up

The T1 Series consists of two CPU versions, T1 and T1S. The T1S is called the Super T1, it is an enhanced version of the standard T1. Each version consists of different models, see following chart. There are a total of 12 different types of T1 Series controllers.

## T1 Series Line-up

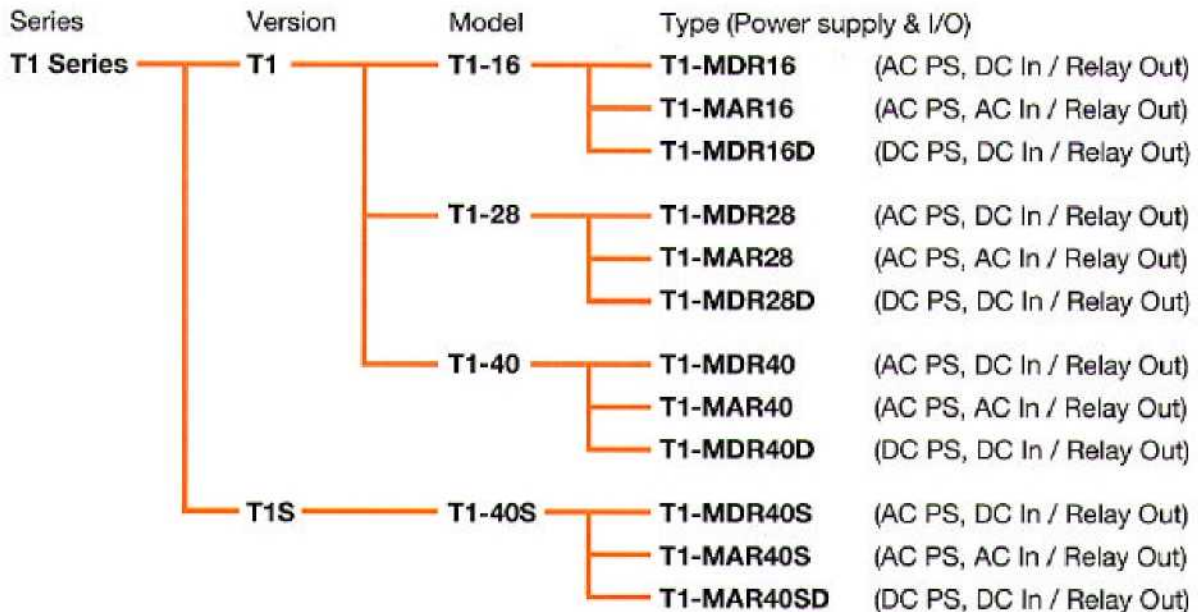

## T1 vs. T1S Comparison

<b>T1</b>	2 k steps of program memory, Standard functions
<b>T1S</b>	8 k steps of program memory (4 k mode or 8 k mode), All the functions of the T1 plus built-in Clock/calendar, built-in RS-485 communication port, on-line programming function (4 k mode only), on-line EEPROM write function, expanded data memory, and expanded instruction set.

## T1-16 (I/O non-expandable)



Type	Description
<b>T1-MDR16 (TDR116*6S)</b>	Power supply: 100—240 Vac Input: 8 points, dry contact Output: 6 points, relay and 2 points, transistor
<b>T1-MAR16 (TAR116*6S)</b>	Power supply: 100—240 Vac Input: 8 points, 100—120 Vac Output: 6 points, relay and 2 points, triac
<b>T1-MDR16D (TDR116*3S)</b>	Power supply: 24 Vdc Input: 8 points, 24 Vdc Output: 6 points, relay and 2 points, transistor

## T1-28 (I/O non-expandable)



Type	Description
<b>T1-MDR28</b> <b>(TDR128*6S)</b>	Power supply: 100— 240 Vac Input: 14 points, 24 Vdc Output: 12 points, relay and 2 points, transistor
<b>T1-MAR28</b> <b>(TAR128*6S)</b>	Power supply: 100— 240 Vac Input: 14 points, 100—120 Vac Output: 12 points, relay and 2 points, triac
<b>T1-MDR28D</b> <b>(TDR128*3S)</b>	Power supply: 24 Vdc Input: 14 points, 24 Vdc Output: 12 points, relay and 2 points, transistor

## T1-40 (I/O expandable)

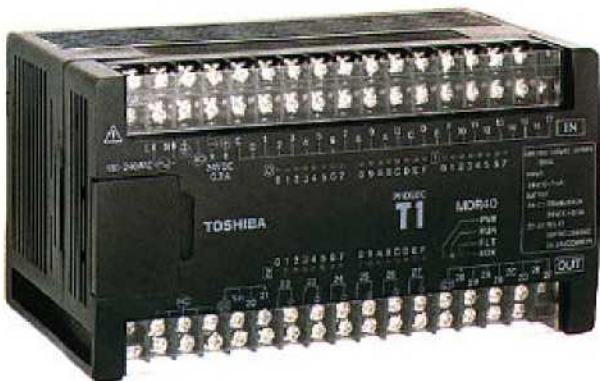

Type	Description
<b>T1-MDR40</b> <b>(TDR140*6S)</b>	Power supply: 100— 240 Vac Input: 24 points, 24 Vdc Output: 14 points, relay and 2 points, transistor
<b>T1-MAR40</b> <b>(TAR140*6S)</b>	Power supply: 100— 240 Vac Input: 24 points, 100—120 Vac Output: 14 points, relay and 2 points, triac
<b>T1-MDR40D</b> <b>(TDR140*3S)</b>	Power supply: 24 Vdc Input: 24 points, 24 Vdc Output: 14 points, relay and 2 points, transistor

## T1-40S (I/O expandable)

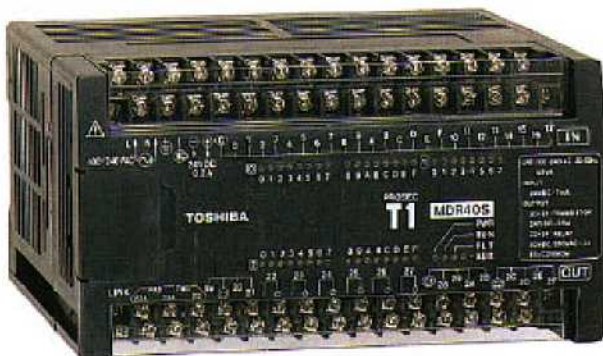

Type	Description
<b>T1-MDR40S</b> <b>(TDR140S6S)</b>	Power supply: 100— 240 Vac Input: 24 points, 24 Vdc Output: 14 points, relay and 2 points, transistor
<b>T1-MAR40S</b> <b>(TAR140S6S)</b>	Power supply: 100— 240 Vac Input: 24 points, 100—120 Vac Output: 14 points, relay and 2 points, triac
<b>T1-MDR40SD</b> <b>(TDR140S3S)</b>	Power supply: 24 Vdc Input: 24 points, 24 Vdc Output: 14 points, relay and 2 points, transistor

# T1/T1S Common Features

## T-Series Compatible

The HP911A Handy Programmer and the T-PDS (T-Series Program Development System) software program the entire family of T-Series programmable controllers. Programs written for the T1/T1S are upward compatible to other T-Series controllers.



## High-Performance Software

The T1 offers 17 basic ladder instructions and 76 insertable function instructions. The T1S offers 21 basic ladder instructions and 99 insertable function instructions.

Subroutines, Interrupt functions, Indirect addressing, For/Next loops, Increment/Decrement, Pre-derivative real PID, etc. are standard on the T1/T1S. These functions allow the T1/T1S to be applied to the most demanding control applications.

## High-Speed Processing

Sophisticated machine control applications require high speed data manipulation. The T1/T1S is designed to meet these requirements. High-speed data processing is the T1/T1S's key feature.

- 1.4  $\mu$ s per Contact
- 2.3  $\mu$ s per Coil
- 4.2  $\mu$ s per Transfer
- 6.5  $\mu$ s per Addition
- 8.8  $\mu$ s per Multiplication
- 5.0  $\mu$ s per Comparison

The T1/T1S also supports the immediate interrupt function (DC input types only). This allows inputs to be recognized and outputs turned ON/OFF independent of the program scan.

## Built-in Computer Interface

The T1/T1S's RS-232C programmer port can accept computer read/write commands. This results in easy connection to higher level computers, operator interface units, etc. By using the multi-drop adapter (CU111), up to 32 T1/T1Ss can be connected to a master computer. The T1/T1S has the same communications protocol as other members in the T-Series family.

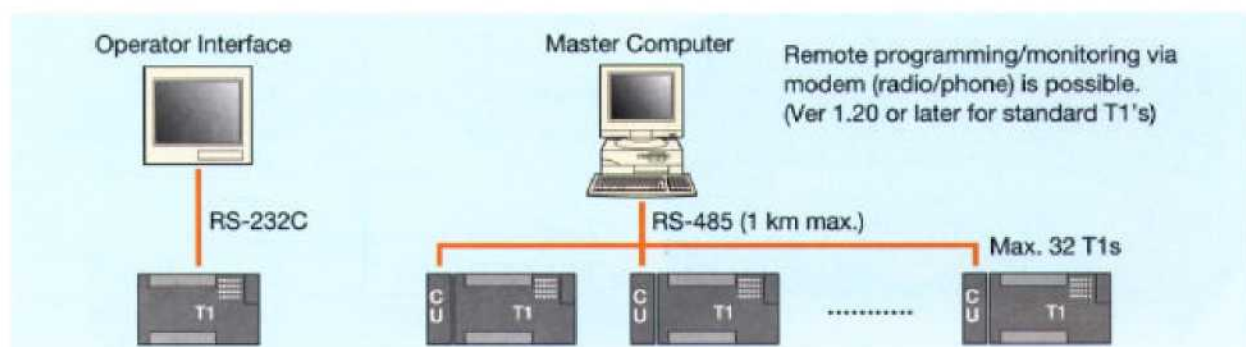

## ASCII Message Storage in Register & Program Memory

T1/T1S can store ASCII messages in either program memory, register memory, or both. There are over 1,000 data registers on the standard T1 and over 4,000 data registers on the T1S that can be used for ASCII message storage. This makes T1s ideal for use with the low-cost operator interface stations that require messages to be stored in the PLC.

## High-Speed Counter Input

The T1/T1S has two high-speed counter inputs (DC input types only). These 5 kHz counters can be used independently (of each other and of CPU scan) for discrete parts count in applications requiring high-speed compare, reset, and strobe. The counters can also be used together as a quadrature counter.

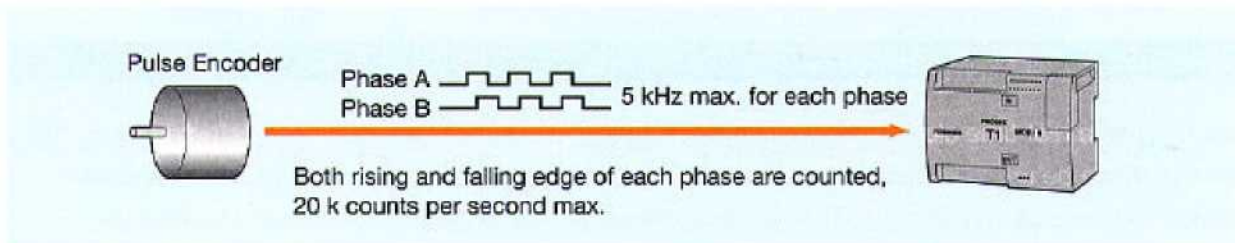

## Analog Register Adjustment

Each T1/T1S has two terminals (which can be adjusted with a screwdriver) that vary the value in two separate registers. These registers can be used as presets for timers and counters, maximum, minimum, or equal values for comparisons, add or subtract adjustments, etc.

## Pulse/PWM Output

An output from the T1/T1S can generate a variable frequency output (5 kHz max.). The output can also be driven so that it switches ON and OFF at varying duty cycles. This output can be used to drive a stepper motor or to simulate an analog output (DC input types only).

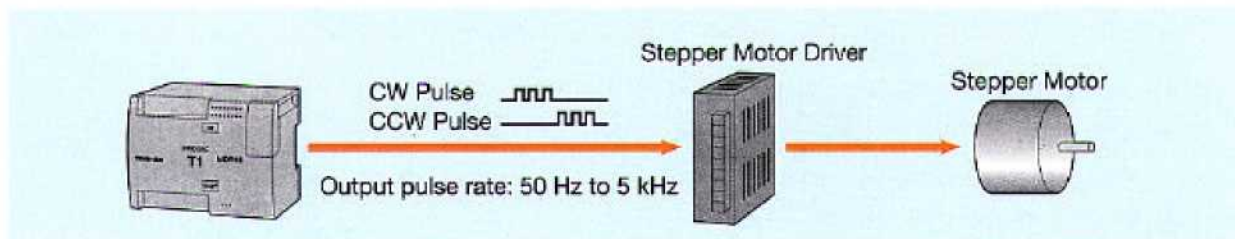

## Password Protection

The T1/T1S can be programmed with no password, or with one of three selectable protection levels. This is a serious password utility. There is no way for anyone to recover, modify or view a fully protected program.

# T1S Features

## Large Program Memory

Tired of loading a micro PLC with different programs or different recipes for each different part or different process? The T1S has 8 k steps of program memory & 4 k words of data memory. Several programs and recipes can be easily loaded into a T1S. Then, simply select the program or recipe to be executed.

## On-line Program Changes

In the 4 k memory mode, it is possible to make program changes and write to the internal EEPROM while the T1S is executing the user application program. This feature is very important in process control applications where it is not always possible to stop the process just to add an additional interlock or permissive.

## Real-time Clock/Calendar

The T1S has a real-time clock/calendar for year, month, day, day of the week, hour, minute, and second. It can be used for performing scheduled operations (each Sunday at 6 pm), time and date stamping event occurrences, etc. The real-time clock/calendar is backed up by built-in capacitor. The back-up period is more than 7 days (25°C).

## Built-in RS-485 Communication Port

The T1S has a built-in RS-485 multi-purpose communication port. This port can operate in one of three (3) different modes.

### Computer link mode

T-series computer link protocol can be used in this mode. A maximum of 32 T1Ss can be connected to a master computer, operator interface station, or other higher level controller. In this mode, the computer can read and write to all the registers in the T1S. The T-series PLC programming software (T-PDS) can also be used in this configuration to program each of the T1S's.

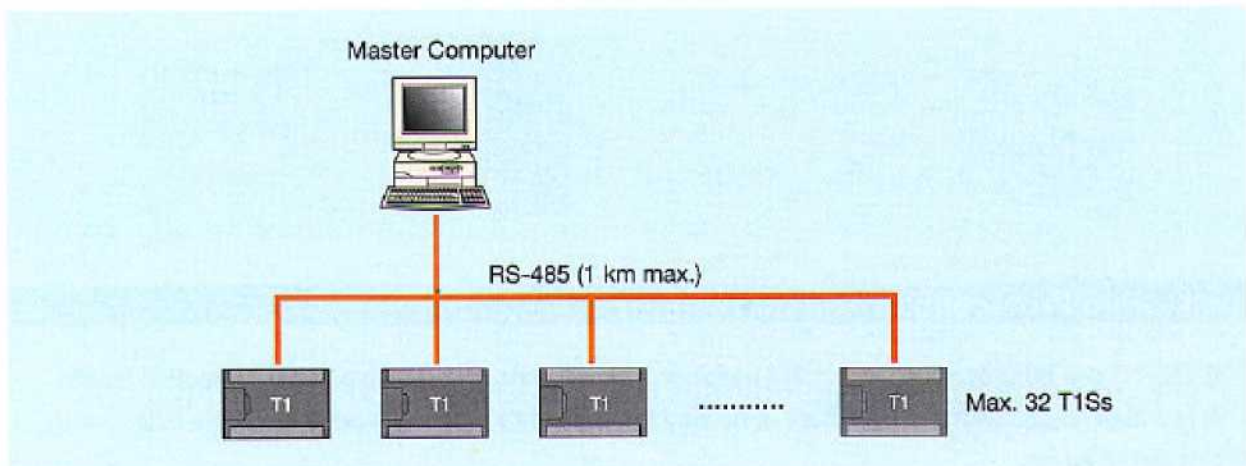



## Built-in RS-485 Communication Port (cont'd)

### Free ASCII mode

In this mode, user defined ASCII messages can be transmitted and received. A terminal, printer, bar-code reader, or other serial ASCII device can be directly connected to the T1S. This mode allows the T1S to communicate with other PLCs (T1, T2E, T2N, etc.), Inverters (VF-S7/A5, G3), motor protection relays (S2E21), and other devices with a simple ASCII read/write protocol.

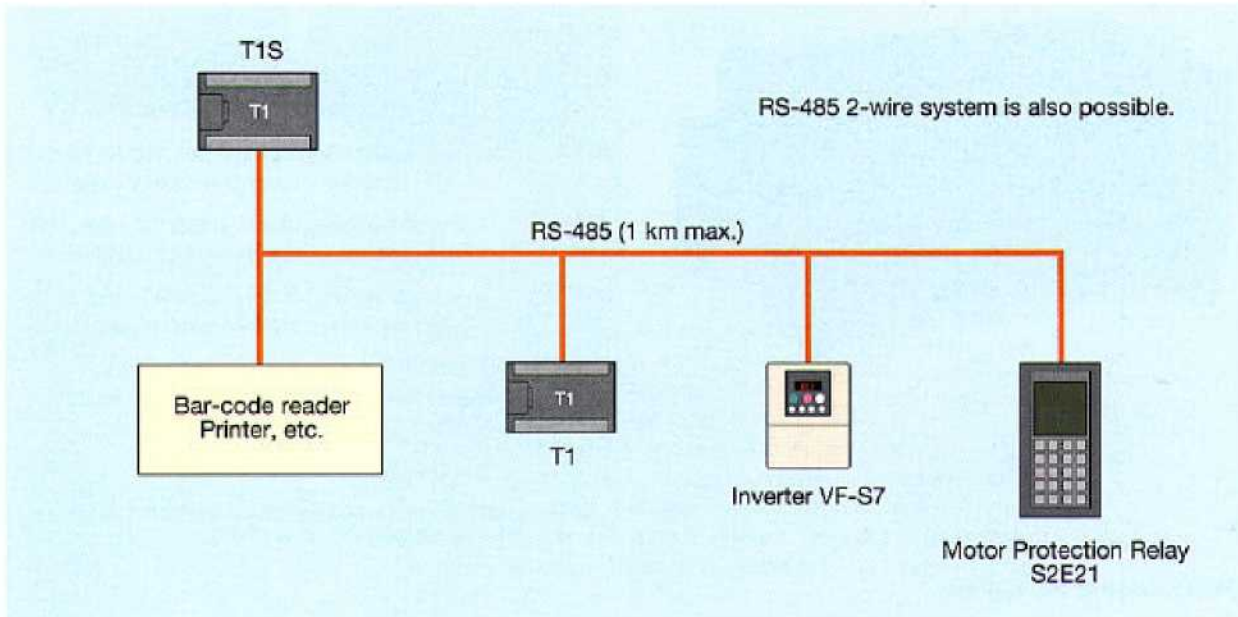

### Data link mode

In this mode, two (2) PLCs (any combination of T1S, T2E or T2N) can be directly linked together. This direct link is inexpensive, easily configured and require no special programming. Data registers D0000 to D0031 are used for the data transfer.

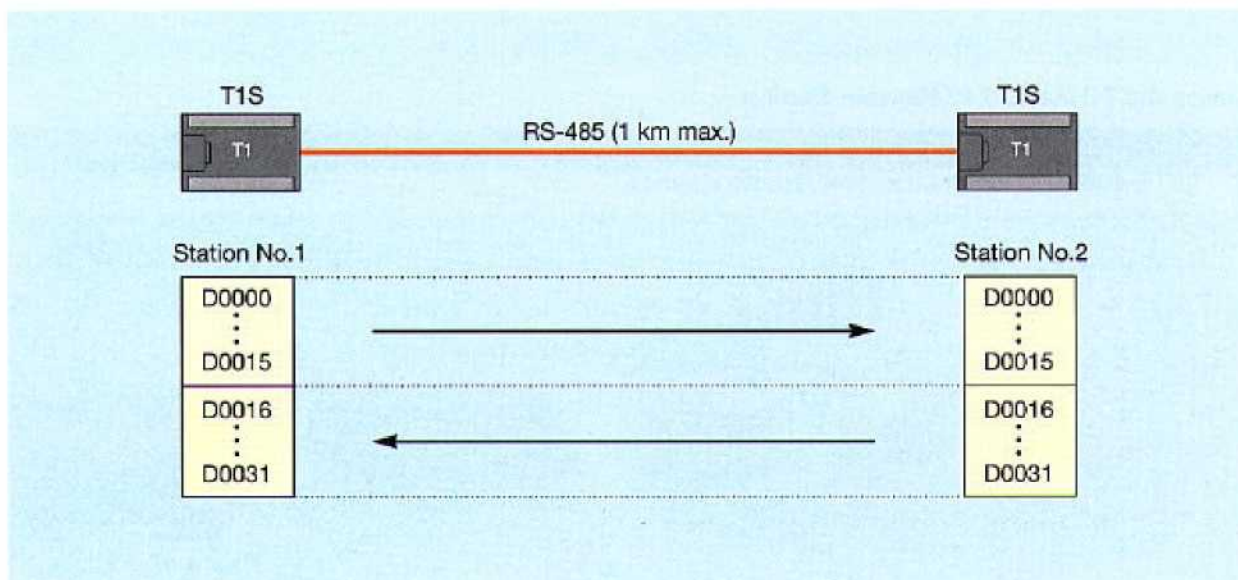

# I/O Expansion

## Option Cards

These option cards are extremely compact I/O expansion cards. They are approximately 1/2 the size of a credit card. The T1-40/T1-40S can hold two option cards inserted in the end of the controller. By using the option cards, the T1-40/T1-40S can expand its I/O without increasing panel mounting space. The following eight types of option cards are available.

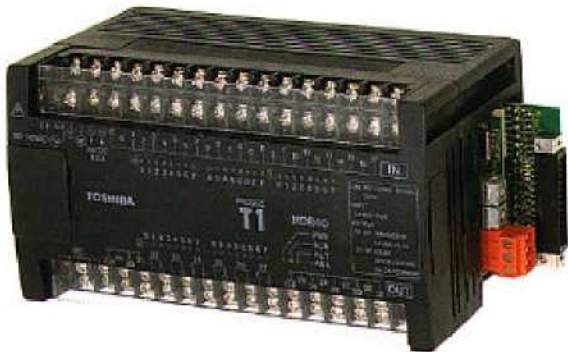

Type	Description
<b>DI116</b>	16 points, 24 Vdc input, 5 mA (Note)
<b>DO116</b>	16 points, 24 Vdc output, 100 mA (Note)
<b>DD116</b>	8 points, 24 Vdc input, 5 mA 8 points, 24 Vdc output, 100 mA (Note)
<b>AD121</b>	1 channel analog input, 0 to 5 V/0 to 20 mA, 12-bit resolution, internal-external isolation
<b>AD131</b>	1 channel analog input, -10 to 10 V, 12-bit resolution, internal-external isolation
<b>DA121</b>	1 channel analog output, 0 to 20 mA, 12-bit resolution, internal-external isolation
<b>DA131</b>	1 channel analog output, -10 to 10 V, 12-bit resolution, internal-external isolation
<b>FR112</b>	TOSLINE-F10 remote station, 1 word input + 1 word output

Note: Cable side connector is not included with the DI, DO, or DD card. It is separately available. (PT15S or PT15F)

### Using Analog I/O Cards:

The T1-40/T1-40S's PID function and analog I/O option cards enable the T1-40/T1-40S to be applied to process control applications.

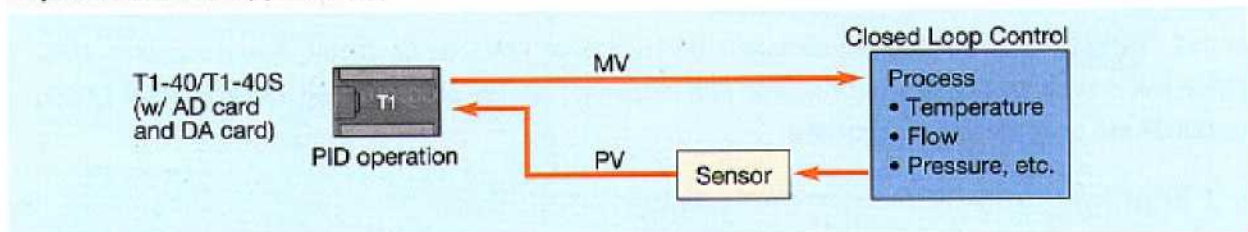

### Using the TOSLINE-F10 Remote Station:

The TOSLINE-F10 is a high-speed field level network. In a TOSLINE-F10 network, the T1-40/T1-40S work as an intelligent remote stations.

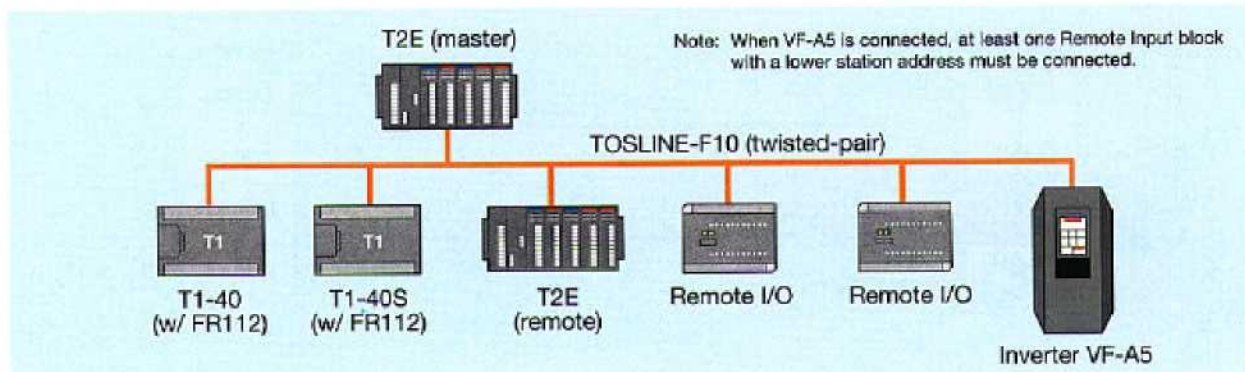

## Expansion Racks (for mounting T2 I/O modules)

A 2 or 4 slot expansion rack can be connected to the T1-40/T1-40S. By connecting the expansion rack, T2 series I/O modules can be used with the T1-40/T1-40S. Internal 5 Vdc power is supplied from the T1-40/T1-40S.



Type	Description
<b>BU152</b>	2 modules, with 0.15 m cable
<b>BU154</b>	4 modules, with 0.15 m cable

### Available T2 series I/O modules:

Type	Name	Specifications
<b>DI31</b>	DC input	16 points, 12—24 Vdc/ac input, 8 mA
<b>DI32</b>		32 points, 24 Vdc input, 5 mA (connector type)
<b>DI235</b>		64 points, 24 Vdc input, 4 mA (connector type)
<b>IN51</b>	AC input	16 points, 100—120 Vac input, 7 mA
<b>IN61</b>		16 points, 200—240 Vac input, 6 mA
<b>RO61</b>	Relay output	12 points, 240 Vac/24 Vdc output, 2 A/point (max.)
<b>RO62</b>		8 points (isolated), 240 Vac/24 Vdc output, 2 A/point (max.)
<b>DO31</b>	Transistor output	16 points, 5—24 Vdc output (current sink), 1 A/point (max.)
<b>DO32</b>		32 points, 5—24 Vdc output (current sink), 0.1 A/point (max.)
<b>DO235</b>		64 points, 5—24 Vdc output (current sink), 0.1 A/point (max.)
<b>DO233P</b>		16 points, 24 Vdc output (current source), 1 A/point (max.)
<b>AC61</b>	Triac output	12 points, 100—240 Vac output, 0.5 A/point (max.)
<b>AI21</b>	Analog input	4 channels, 4 to 20 mA/1 to 5 V input, 8-bit resolution
<b>AI31</b>		4 channels, 0 to 10 V input, 8-bit resolution
<b>AI22</b>		4 channels, 4 to 20 mA/1 to 5 V input, 12-bit resolution
<b>AI32</b>		4 channels, -10 to 10 V input, 12-bit resolution
<b>AO31</b>	Analog output	2 channels, 4 to 20 mA/1 to 5 V/0 to 10 V output, 8-bit resolution
<b>AO22</b>		2 channels, 4 to 20 mA/1 to 5 V output, 12-bit resolution
<b>AO32</b>		2 channels, -10 to 10 V output, 12-bit resolution
<b>PI21</b>	Pulse input	1 channel plus input, 5/12 V, 100 kpps (max.)
<b>MC11</b>	Position control	1 axis position control (pulse output), 5—24 Vdc, 200 kpps (max.)
<b>CF211</b>	Communication I/F	1 port of RS-232C, free ASCII format, 300 to 19200 bps, 320 bytes (max.)

## Expansion Units

A 32 point expansion unit can be connected to the T1-40/T1-40S. A 0.5 m cable is included with the expansion unit. Internal 5 Vdc power is supplied from the T1-40/T1-40S, 24 Vdc power for the output relay coils is required from an external source (such as the controller).



Type	Description
<b>T1-EDR32</b>	16 points, 24 Vdc input, 7 mA 16 points, relay output, 2 A/point (max.)
<b>T1-EAR32</b>	16 points, 100—120 Vac input, 7 mA 16 points, relay output, 2 A/point (max.)

# Programming Tools

## T-Series Program Development System (T-PDS)

The T-Series Program Development System (T-PDS) is a software program that runs on any Toshiba's Notebook computer or other IBM-PC compatible personal computer. The T-PDS software supports on-line/off-line programming, debugging and program documentation for all T-Series programmable controllers; T1/T1S, T2/T2E/T2N and T3/T3H.

The T-PDS software has:

- A full-feature program edit that includes cut & paste, search & replace, insert, delete, etc.
- Group programming and block merge.
- On-line programming & EEPROM write. (T1S)
- Load, save and compare programs between disk file and CPU.
- Monitor power-flow status of on-line ladder program and display of register values.
- Sampling trace screen for checking event time sequences.
- Disable inputs and force coils ON or OFF from keyboard.
- Document programs with commentary.
- Print map options such as register values, register/device usage, full cross-reference, etc.
- Built-in Modem initialize and Dial-up.

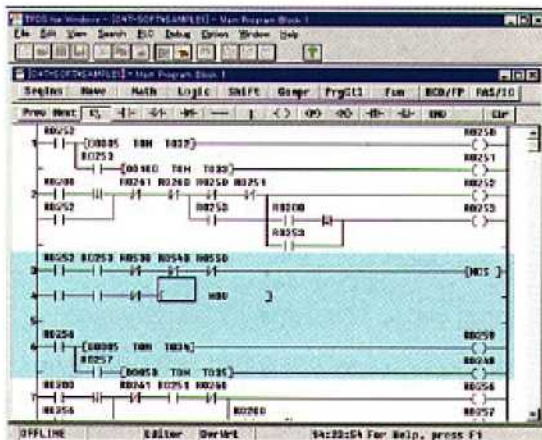
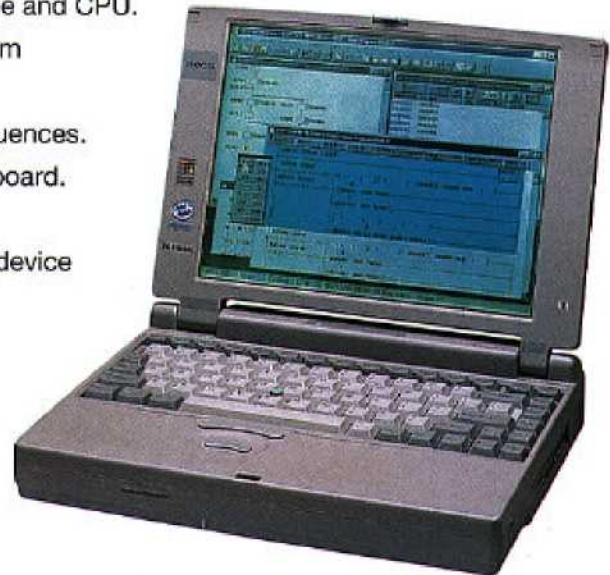

Program edit screen

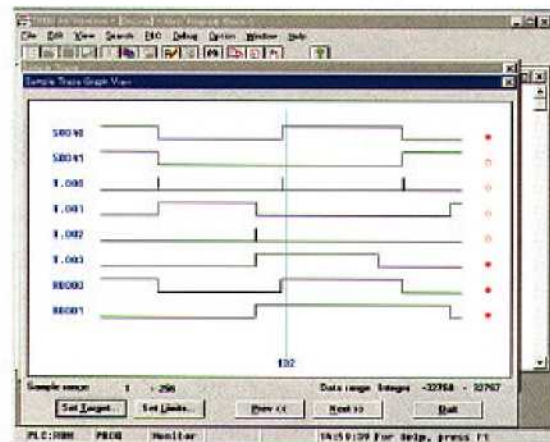

Sampling trace screen

Note:

For the T1S, the following T-PDS versions are required.

- T-PDS (Windows) ... Ver 1.2 or later
- T-PDS (MS-DOS) ... Ver 2.1 or later

## Handy Programmer (HP911A)



**Note:**  
Some T1S functions are limited with using the HP911A.

The HP911A is a hand-held graphic programmer. Its portability makes it ideal for maintenance use at remote locations. The HP911A has all the features of a full size programming terminal. (2 m cable for T1 is included)

- Ladder logic programming of T-Series programmable controllers T1/T1S, T2/T2E/T2N and T3.
- Built-in EEPROM allows program copy between T-Series controllers.
- Two display modes,
  - Normal: 5 lines and 12 columns
  - Zoom: Full device description
- Data monitor for I/O and internal registers.
- On-line programming & EEPROM write. (T1S)
- On-line data set & I/O force.
- Backlit LCD display for better operation in dim light.

## Program Storage Module (RM102)



The RM102 is an external memory device, which can store a T1/T1S program. By using the RM102, program transfer from a master T1/T1S can be easily done without the need for a computer or hand held programmer. Two-button operation makes program loading/saving accessible to anyone. However, if a password is used in the T1/T1S, the password in the RM102 must match before a program load is executed.

## Multi-drop Adapter (CU111)



The CU111 is an RS-232C/RS-485 converter dedicated to the T1 Series. By using the CU111, up to 32 T1/T1Ss can be connected to a master computer or higher level controller via an RS-485 link. The master computer can run a SCADA, MMI or DDE Server program. The T-PDS programming software can also be used through the RS-485 link to program or monitor each individual T1/T1S. (T1 version 1.20 or later is required for connecting the T-PDS programming software)

# Instruction Set

## Basic Instructions

FUN No.	Symbol	Name	Available	
			T1	T1S
		NO contact	✓	✓
		NC contact	✓	✓
		Transitional contact (rising edge)	✓	✓
		Transitional contact (falling edge)	✓	✓
		Coil	✓	✓
		Forced coil (debugging purpose only)	✓	✓
		Inverter	✓	✓
		Invert coil	✓	✓
		Positive pulse contact		✓
		Negative pulse contact		✓
		Positive pulse coil		✓
		Negative pulse coil		✓
	MCS	Master control set	✓	✓
	MCR	Master control reset	✓	✓
	JCS	Jump control set	✓	✓
	JCR	Jump control reset	✓	✓
	TON	ON delay timer	✓	✓
	TOF	OFF delay timer	✓	✓
	SS	Single-shot timer	✓	✓
	CNT	Counter	✓	✓
	END	End	✓	✓

## Function Instructions

FUN No.	Symbol	Name	Available	
			T1	T1S
18	MOV	Data transfer	✓	✓
19	DMOV	Double-word data transfer	✓	✓
20	NOT	Invert transfer	✓	✓
22	XCHG	Exchange	✓	✓
24	TINZ	Table initialize		✓
25	TMOV	Table block transfer		✓
26	TNOT	Table invert transfer		✓
27	+	Addition	✓	✓
28	-	Subtraction	✓	✓
29	*	Multiplication	✓	✓
30	/	Division	✓	✓
31	D+	Double-word addition	✓	✓
32	D-	Double-word subtraction	✓	✓
35	+C	Addition with carry	✓	✓
36	-C	Subtraction with carry	✓	✓
39	U*	Unsigned multiplication		✓
40	U/	Unsigned division		✓
41	DIV	Unsigned double/single division	✓	✓
43	+1	Increment	✓	✓
45	-1	Decrement	✓	✓
48	AND	AND	✓	✓
50	OR	OR	✓	✓
52	EOR	Exclusive OR	✓	✓
56	MAVE	Moving average		✓
61	DFL	Digital filter		✓
62	HTOA	HEX to ASCII conversion		✓
63	ATOH	ASCII to HEX conversion		✓
64	TEST	Bit test	✓	✓
68	SHR1	1 bit shift right	✓	✓
69	SHL1	1 bit shift left	✓	✓
70	SHRn	n bits shift right	✓	✓
71	SHLn	n bits shift left	✓	✓
74	SR	Shift register	✓	✓
75	DSR	Bi-directional shift register	✓	✓
78	RTR1	1 bit rotate right	✓	✓
79	RTL1	1 bit rotate left	✓	✓
80	RTRn	n bits rotate right	✓	✓
81	RTLn	n bits rotate left	✓	✓
90	MPX	Multiplexer	✓	✓
91	DPX	Demultiplexer	✓	✓

FUN No.	Symbol	Name	Available	
			T1	T1S
96	>	Greater than	✓	✓
97	>=	Greater than or equal	✓	✓
98	=	Equal	✓	✓
99	<>	Not equal	✓	✓
100	<	Less than	✓	✓
101	<=	Less than or equal	✓	✓
102	D>	Double-word greater than	✓	✓
103	D>=	Double-word greater than or equal	✓	✓
104	D=	Double-word equal	✓	✓
105	D<>	Double-word not equal	✓	✓
106	D<	Double-word less than	✓	✓
107	D<=	Double-word less than or equal	✓	✓
108	U>	Unsigned greater than		✓
109	U>=	Unsigned greater than or equal		✓
110	U=	Unsigned equal		✓
111	U<>	Unsigned not equal		✓
112	U<	Unsigned less than		✓
113	U<=	Unsigned less than or equal		✓
114	SET	Device/register set	✓	✓
115	RST	Device/register reset	✓	✓
118	SETC	Set carry	✓	✓
119	RSTC	Reset carry	✓	✓
120	ENC	Encode	✓	✓
121	DEC	Decode	✓	✓
122	BC	Bit count		✓
128	CALL	Subroutine call	✓	✓
129	RET	Subroutine return	✓	✓
132	FOR	FOR-NEXT loop (FOR)	✓	✓
133	NEXT	FOR-NEXT loop (NEXT)	✓	✓
137	SUBR	Subroutine entry	✓	✓
140	EI	Enable interrupt	✓	✓
141	DI	Disable interrupt	✓	✓
142	IRET	Interrupt return	✓	✓
143	WDT	Watchdog timer reset	✓	✓
144	STIZ	Step sequence initialization	✓	✓
145	STIN	Step sequence input	✓	✓

FUN No.	Symbol	Name	Available	
			T1	T1S
146	STOT	Step sequence output	✓	✓
147	F/F	Flip flop	✓	✓
149	U/D	Up / down counter	✓	✓
154	CLND	Calendar set		✓
155	CLDS	Calendar operation		✓
156	PID3	Pre-derivative real PID	✓	✓
160	UL	Upper limit		✓
161	LL	Lower limit		✓
162	MAX	Maximum value		✓
163	MIN	Minimum value		✓
164	AVE	Average value		✓
165	FG	Function generator	✓	✓
180	ABS	Absolute value	✓	✓
182	NEG	Two's complement	✓	✓
183	DNEG	Double-word two's complement	✓	✓
185	7SEG	7-segment decode	✓	✓
186	ASC	ASCII conversion	✓	✓
188	BIN	Binary conversion	✓	✓
190	BCD	BCD conversion	✓	✓
235	I/O	Direct input/output	✓	✓
236	XFER	Expanded data transfer	✓	✓
237	READ	Special module data read	✓	✓
238	WRITE	Special module data write	✓	✓

# Specifications

Functional Specifications					
Model		T1-16	T1-28	T1-40	T1-40S
Control method		Stored program, cyclic scan system			
Scan system		Floating scan or constant scan (10—200 ms, 10 ms units)			
I/O update		Batch I/O refresh (direct I/O instruction available)			
Program memory		RAM (capacitor back-up) and EEPROM (no back-up battery required)			
RAM memory back-up		6 hours (25°C)			168 hours (25°C)
Program capacity		2 k steps			8 k steps (4 k or 8 k mode)
Programming language		Ladder diagram with function block			
Instructions		Basic ladder instructions: 17 Function block instructions: 76			Basic: 21 Function: 99
Execution speed		1.4 $\mu$ s/contact, 2.3 $\mu$ s/coil, 4.2 $\mu$ s/16-bit transfer, 6.5 $\mu$ s/16-bit addition			
Program types		1 main program 1 sub-program (initial program) 1 timer interrupt (interval: 5 to 1000 ms, 5 ms units) 4 I/O interrupt (high-speed counter and interrupt input) 16 subroutines (nesting not available)			
I/O capacity		16 points (8 in/8 out)	28 points (14 in/14 out)	40 points (24 in/16 out), expandable up to 328 points	
Input specification	DC input type	Dry contact (AC PS) 24 Vdc, 7mA (DC PS) (current sink or source)	24 Vdc, 7 mA (current sink or source) Dry contact input is also available by using 24 Vdc service power		
	AC input type	100—120 Vac, 7 mA			
Output specification	DC input type	Relay: 240 Vac/24 Vdc, max. 2 A/point Transistor (2 points): 24 Vdc, max. 0.5 A/point			
	AC input type	Relay: 240 Vac/24 Vdc, max. 2 A/point Triac (2 points): 100—240 Vac, max. 1 A/point			
I/O terminal block		Fixed	Removable		
User data	Auxiliary relay	1024 points/64 words (R/RW)			4096 points / 256 words (R/RW)
	Special relay	1024 points/64 words (S/SW)			
	Timer	64 points (T./T), 32 @ 0.01 s, 32 @ 0.1 s			256 points (T./T) 64 @ 0.01 s, 192 @ 0.1 s
	Counter	64 points (C./C)			256 points (C./C)
	Data register	1024 words (D)			4096 words (D)
	Index register	3 words (I, J, K)			
Real-time clock/calendar		No			Yes, ( $\pm$ 30 s/month)
Special I/O functions		High speed counter (2 single or 1 quadrature) or Interrupt input (2 points), Adjustable analog register (2 points), Pulse output (CW+CCW or pulse+direction) or PWM output			
Communications interface		1 port of RS-232C(programmer port)...Programmer or Computer link			1 port of RS-485 -Programmer, -Computer link, -Data link, -Free ASCII
Debug support function		Sampling trace (8 devices - 256 times or 1 register - 128 times)			Sampling trace (8 device and 3 register - 256 times)
		—			On-line programming
		—			On-line EEPROM write



## General Specifications

Model	T1-16	T1-28	T1-40	T1-40S
Power supply voltage	100 to 240 Vac (+10%, -15%), 50/60Hz / 24 Vdc (+20%, -15%)			
Power consumption	30 VA or less (AC) / 12 W or less (DC)		36 VA or less (AC) / 18 W or less (DC)	45 VA or less (AC) / 18 W or less (DC)
Retentive power interruption	10 ms or less			
Withstand voltage	1500 Vac—1 minute (between power terminals and ground terminal)			
Ambient temperature	0 to 55 °C (operation), -20 to 75 °C (storage)			
Ambient humidity	20 to 90% RH, no condensation			
Noise immunity	1000 V p-p/1 μs, 89/336/EEC (EMC directive)			
Vibration immunity	16.7 Hz—3 mm p-p (3 mutually perpendicular axis)			
Shock immunity	98 m/s <sup>2</sup> (10 g), (3 shocks per axis, on 3 mutually perpendicular axis)			
Standard	UL/c-UL, CE			

## External Dimensions

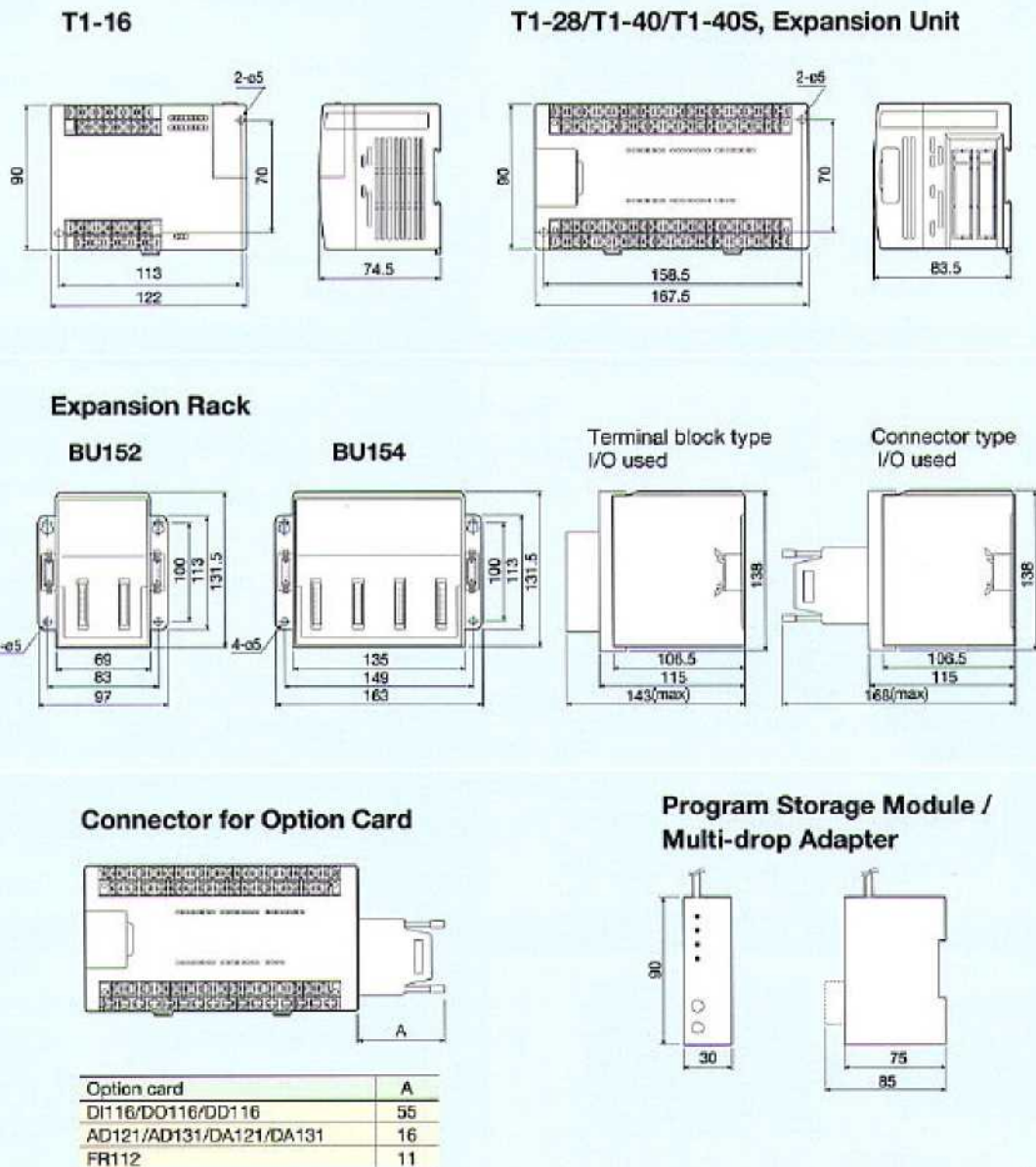

Unit: mm

# Ordering Information

Item	Description	Type code	Part number
T1-16	AC PS	DC input	T1-MDR16 TDR116*6S
		AC input	T1-MAR16 TAR116*6S
	DC PS	DC input	T1-MDR16D TDR116*3S
T1-28	AC PS	DC input	T1-MDR28 TDR128*6S
		AC input	T1-MAR28 TAR128*6S
	DC PS	DC input	T1-MDR28D TDR128*3S
T1-40	AC PS	DC input	T1-MDR40 TDR140*6S
		AC input	T1-MAR40 TAR140*6S
	DC PS	DC input	T1-MDR40D TDR140*3S
T1-40S	AC PS	DC input	T1-MDR40S TDR140S6S
		AC input	T1-MAR40S TAR140S6S
	DC PS	DC input	T1-MDR40SD TDR140S3S
Option card	16 pts DC input	DI116	TDI116*BS
	16 pts DC output	DO116	TDO116*BS
	8 in / 8 out combo	DD116	TDD116*BS
	1 ch analog input, 0—5 V/0—20 mA	AD121	TAD121*BS
	1 ch analog input, ±10 V	AD131	TAD131*BS
	1 ch analog output, 0—20 mA	DA121	TDA121*BS
	1 ch analog output, ±10 V	DA131	TDA131*BS
	TOSLINE-F10 remote	FR112	TFR112*BS
Expansion rack	2 slots (w/ 0.15 m cable)	BU152	TBU152**S
	4 slots (w/ 0.15 m cable)	BU154	TBU154**S
Expansion unit	DC input type	T1-EDR32	TDR132E*S
	AC input type	T1-EAR32	TAR132E*S
Peripheral	T-PDS (MS-DOS)	T-PDS	TMM33H1SS
	T-PDS (Windows)	T-PDS Win	TMW33E1SS
	Handy programmer (w/ 2 m cable for T1)	HP911A	THP911A*S
	Program storage module	RM102	TRM102**S
	Multi-drop adapter	CU111	TCU111**S

Item	Description	Type code	Part number	
T2 I/O module	16 pts 24 Vdc input	DI31	EX10*MDI31	
	32 pts 24 Vdc input	DI32	EX10*MDI32	
	64 pts 24 Vdc input	DI235	TDI235**S	
	16 pts 120 Vac input	IN51	EX10*MIN51	
	16 pts 240 Vac input	IN61	EX10*MIN61	
	12 pts relay output	RO61	EX10*MRO61	
	8 pts relay output	RO62	EX10*MRO62	
	16 pts 24 Vdc output	DO31	EX10*MDO31	
	32 pts 24 Vdc output	DO32	EX10*MDO32	
	64 pts 24 Vdc output	DO235	TDO235**S	
	16 pts 24 Vdc output (current source)	DO233P	TDO233P*S	
	12 pts 100—240 Vac output	AC61	EX10*MAC61	
	4 ch Analog input	8-bit	AI21	EX10*MAI21
			AI31	EX10*MAI31
		12-bit	AI22	EX10*MAI22
	2 ch Analog output	8-bit	AO31	EX10*MAO31
		12-bit	AO22	EX10*MAO22
		AO32	EX10*MAO32	
1 ch pulse input	PI21	EX10*MPI21		
Position control	MC11	EX10*MMC11		
Communication I/F	CF211	TCF211**S		
Cable and others	T-PDS cable (5 m)	CJ105	TCJ105*CS	
	RS-232C connector (w/ 2 m cable)	PT16S	TPT16S*AS	
	Option card connector (soldering type)	PT15S	TPT15S*AS	
	Option card connector (flat cable type)	PT15F	TPT15F*AS	
	Empty slot cover (for expansion rack)	—	EX10*ABP1	

# Quality

Quality is a religion at Toshiba. Quality starts at the very basic level, the IC (integrated circuit), and proceeds through design development, assembly, and testing of many different consumer and industrial products.

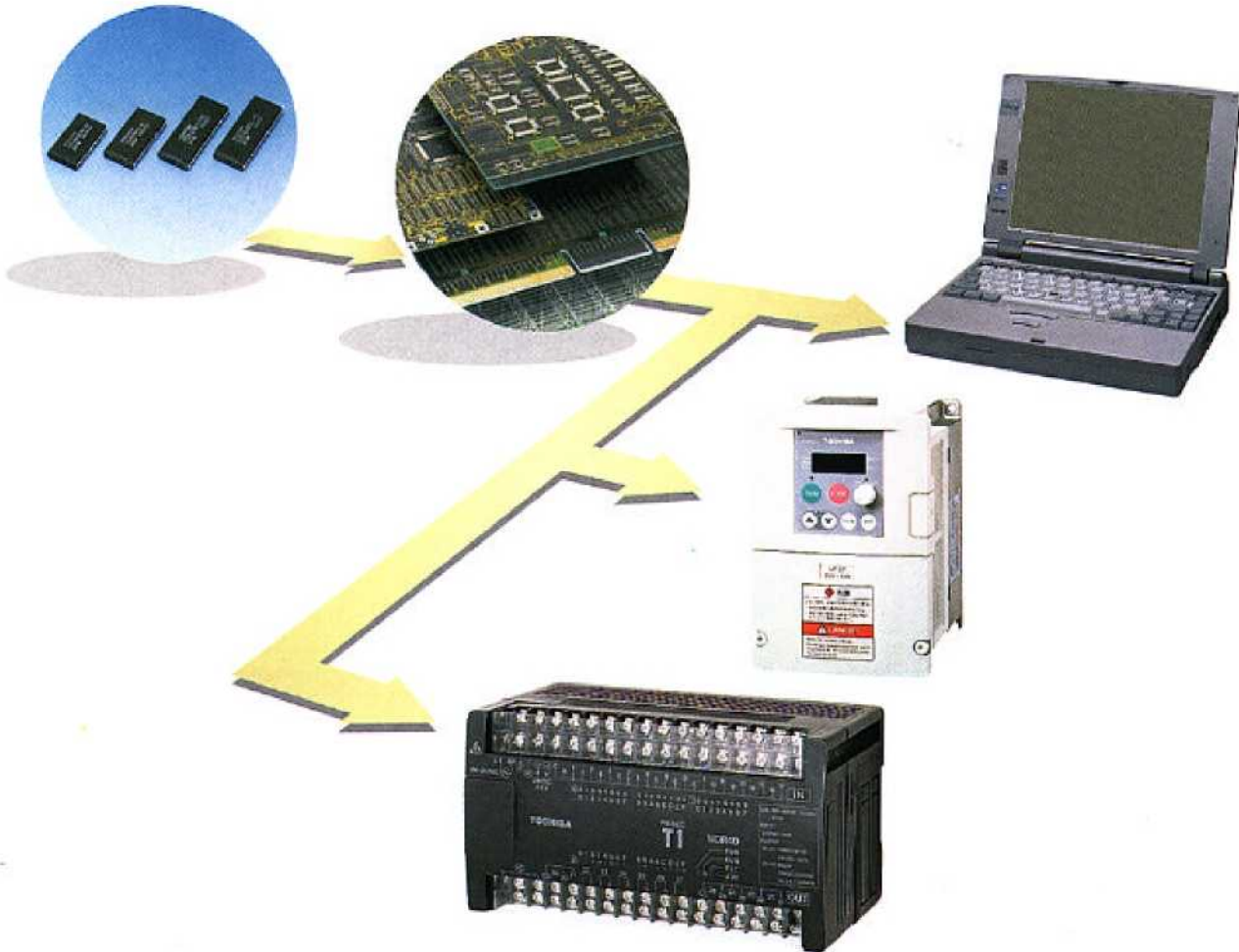

Toshiba corporation's quality management system in design, development and manufacturing of programmable controllers is approved to satisfy the quality management standard ISO9001.



### Safety Precaution

This product is intended to be used for the control of industrial machines and processes.  
Misuse of this product can result in property damage or human injury.  
Read related manuals carefully before using this product.

PROSEC and TOSLINE are registered trademarks of TOSHIBA Corporation.  
IBM is a registered trademark of International Business Machines Corporation.  
MS-DOS and Windows are registered trademarks of Microsoft Corporation.

For further information, please contact your nearest Toshiba Representative or International Operations-Producer Goods.

The data given in this brochure are subject to change without notice.

In Touch with Tomorrow  
**TOSHIBA**

**TOSHIBA CORPORATION**  
Industrial Equipment Department  
1-1, Shibaura 1-chome, Minato-ku,  
Tokyo 105-8001, Japan  
Tel.: (03)3457-4900 Fax.: (03)5444-9268

**Toshiba International Corporation**  
Industrial Division  
Houston U.S.A.  
Tel.: 713-465-0277  
Fax.: 713-466-9773

**Toshiba International Corporation (Europe) Ltd.**  
Middlesex U.K.  
Tel.: 0181-756-6000  
Fax.: 0181-848-4969

**Toshiba International Corporation Pty., Ltd.**  
Sydney Australia  
Tel.: 02-9768-6600  
Fax.: 02-9890-7542

**Toshiba Asia Pacific Pte., Ltd.**

Singapore  
Tel.: 324-1048  
Fax.: 324-5288

Bangkok Office (Thailand)  
Tel.: 02-235-6401/02/03  
Fax.: 02-237-4682

**Toshiba do Brasil, S.A.**  
São Paulo Brasil  
Tel.: 011-7689-7199  
Fax.: 011-7689-7189